

Product information

92 22 07

Universal Tweezers



- Universal Tweezers are suitable for demanding standard applications and precision tasks
- Wide range of designs: straight, angled, gripping surfaces and handles smooth or serrated, with needle points, narrow or blunt tips, as well as different lengths
- For the electronics industry, watchmakers and jewellers
- High quality stainless steel: extremely tough and very good corrosion resistance against a variety of atmospheric environments and many corrosive materials
- Stainless steel

General

Article No.	92 22 07
Reference number	3.SA.B
EAN	4003773054689
Material	stainless steel
Gripping surfaces	smooth gripping surfaces
Weight	15 g
Dimensions	125 x 11 x 10 mm
REACH compliant	does not contain SVHC
RoHS compliant	not applicable

Technical details

Surface	matt finish
Finish	straight
Tips width (A)	0.2 mm
Tips width (B)	0.25 mm
Tweezers tip version	needle-point
Corrosion-resistant	yes
Acid resistance	very good
ESD-tested	no
VDE tested	no
Sectors	Industry electronics
Magnetic	non-magnetisable (80%)

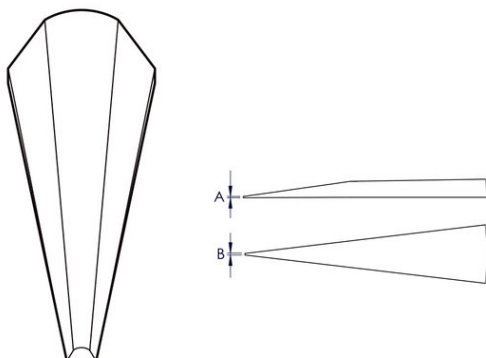

technical change and errors excepted