

Product information

92 21 01 ESD

Universal Tweezers ESD

DIN EN 61340 -5-1



- Electrically dissipative coating: Universal tweezers in the ESD version equalize differences in electrical potential between their user and the workpieces in a controlled manner
- ESD-tested, black epoxy resin coating with a surface resistance between 10^3 and 10^9 ohms
- For the electronics and precision engineering industries
- Antimagnetic to avoid electromagnetic damage
- Wide range of designs: straight, angled, gripping surfaces and handles smooth or serrated, with needle points, narrow or blunt tips
- The high quality stainless steel ensures extreme toughness and very good corrosion resistance against a variety of atmospheric environments and many corrosive materials
- Also available as a set (92 00 01 ESD)
- Stainless steel

General

Article No.	92 21 01 ESD
Reference number	3.SA.NE.B
EAN	4003773086772
Material	stainless steel
Gripping surfaces	smooth gripping surfaces
Weight	15 g
Dimensions	125 x 11 x 12 mm
Standard	DIN EN 61340 -5-1
REACH compliant	does not contain SVHC
RoHS compliant	not applicable

Technical details

Surface	matt finish
Finish	straight
Tips width (A)	0.2 mm
Tips width (B)	0.25 mm
Tweezers tip version	needle-point
Corrosion-resistant	yes
Acid resistance	very good
ESD-tested	yes
VDE tested	no
Sectors	electronics
Magnetic	non-magnetisable (80%)
Behaviour	electrically dissipative

Technical details

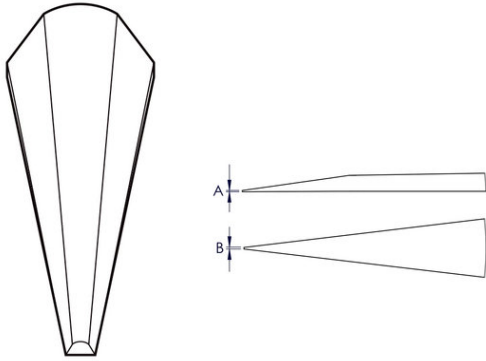

technical change and errors excepted