

Product information

92 11 01 ESD

Cutting Tweezers ESD

DIN EN 61340 -5-1



- For particularly demanding precision work: made from high-quality, martensitic hardened steel, tough and highly resistant to corrosion
- Stainless steel with a slim, tapered design for maximum precision when cutting, dissecting and segmenting extremely small objects in tight spaces
- For the electronics industry, as well as repairs and handicrafts
- Mainly used for cutting soft copper, gold or silver wires, as well as magnetic wires
- With extremely hard and sharp oblique cutting nippers
- Also available as an ESD-version: with black epoxy resin coating and a surface resistance between 10^3 and 10^9 ohms
- ESD version only: this allows to compensate in a controlled manner the differences in potential between the operator and electronic components
- Stainless steel

General

Article No.	92 11 01 ESD
Reference number	15AGW.S.N.0
EAN	4003773086727
Material	stainless steel
Weight	26 g
Dimensions	115 x 11 x 17 mm
Standard	DIN EN 61340 -5-1
REACH compliant	does not contain SVHC
RoHS compliant	not applicable

Technical details

Surface	matt finish
Finish	bent
Tips width (A)	4.75 mm
Tips width (B)	10 mm
Tweezers tip version	Cutting Edges
Corrosion-resistant	yes
ESD-tested	yes
VDE tested	no
Sectors	Industry electronics
Behaviour	electrically dissipative

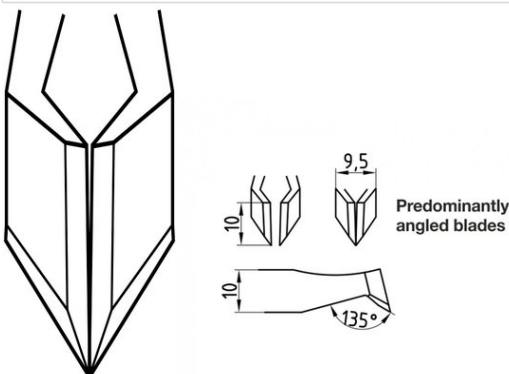

technical change and errors excepted

