

Product information

20 02 140

- Flat, short, wide jaws
- Knurled gripping surfaces
- Special tool steel, forged, oil-hardened

Flat Nose Pliers

DIN ISO 5745



General

Article No.	20 02 140
EAN	4003773043386
Pliers	black atramentized
Head	polished
Handles	with multi-component grips
Weight	137 g
Dimensions	140 x 54 x 18 mm
Standard	DIN ISO 5745
REACH compliant	does not contain SVHC
RoHS compliant	not applicable

Technical details

Jaw thickness (joint) (T1)	9.5 mm
Jaw length (L3)	28.0 mm
Head width (W3)	15.5 mm

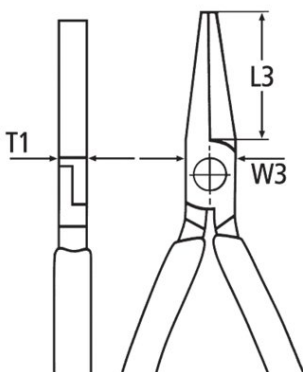

technical change and errors excepted

